

கிடைக்கக்கூடிய அனைத்து உரிமைகளும் பதிப்பரிமையுடையது / All Rights Reserved

ශ්‍රී ලංකා විභාග දෙපාර්තමේන්තුව ශ්‍රී ලංකා විභාග දෙපාර්තමේන්තුව ශ්‍රී ලංකා විභාග දෙපාර්තමේන්තුව ශ්‍රී ලංකා විභාග දෙපාර්තමේන්තුව ශ්‍රී ලංකා විභාග දෙපාර්තමේන්තුව  
 இலங்கைப் பரீட்சைத் திணைக்களம் இலங்கைப் பரීட்சைத் திணைக்களம் இலங்கைப் பரීட்சைத் திணைக்களம் இலங்கைப் பரීட்சைத் திணைக்களம் இலங்கைப் பரීட்சைத் திணைக்களம்  
 Department of Examinations, Sri Lanka Department of Examinations, Sri Lanka Department of Examinations, Sri Lanka Department of Examinations, Sri Lanka Department of Examinations, Sri Lanka  
 இலங்கைப் பரීட்சைத் திணைக்களம் இலங்கைப் பரීட்சைத் திணைக்களம் இலங்கைப் பரීட்சைத் திணைக்களம் இலங்கைப் பரīட்சைத் திணைக்களம் இலங்கைப் பரīட்சைத் திணைக்களம்  
 Department of Examinations, Sri Lanka Department of Examinations, Sri Lanka Department of Examinations, Sri Lanka Department of Examinations, Sri Lanka Department of Examinations, Sri Lanka

84 E I, II

අධ්‍යයන පොදු සහතික පත්‍ර (සාමාන්‍ය පෙළ) විභාගය, 2020  
 கல்விப் பொதுத் தராதரப் பத்திர (சாதாரண தர)ப் பரீட்சை, 2020  
 General Certificate of Education (Ord. Level) Examination, 2020

ශිල්ප කලා I, II  
 நுண்கலை I, II  
 Arts and Crafts I, II

පැය තුනයි  
 மூன்று மணித்தியாலம்  
 Three hours

අමතර කියවීමේ කාලය - මිනිත්තු 10 යි  
 மேலதிக வாசிப்பு நேரம் - 10 நிமிடங்கள்  
 Additional Reading Time - 10 minutes

Use the additional reading time to go through the question paper, select the questions and decide on the questions that you give priority in answering.

### Arts and Crafts I

#### Note :

- Answer all questions.
- In each of the questions 1 to 40, pick one of the alternatives (1), (2), (3), (4) which is correct or most appropriate.
- Mark a cross (X) on the number corresponding to your choice in the answer sheet provided.
- Further instructions are given on the back of the answer sheet. Read and follow them carefully.

- A type of a cottage industry that is included in the folk art field, which was added to the Sri Lankan folk life from the Dutch is,
  - bobbin lace industry.
  - lacquer industry.
  - mask industry.
  - brass industry.
- The meaning indicated by the letter 'H' printed on a pencil used for geometrical and mechanical drawing is the,
  - size of the graphite stick.
  - softness of the graphite stick.
  - hardness of the graphite stick.
  - percentage of graphite in the graphite stick.
- The answer which indicates the correct measurements of internationally accepted standard A4 size paper is,
  - 594mm × 841mm.
  - 420mm × 594mm.
  - 297mm × 420mm.
  - 210mm × 297mm.
- When creating a three dimensional drawing of a solid, the accepted standard line form that shows its invisible edges is,
  - thick continuous lines.
  - discontinuous lines.
  - thin chain lines.
  - chain lines with thick ends.
- The area darkened in this circle is known as,
  - Chord.
  - Quadrant of a circle.
  - Segment of a circle.
  - Sector of a circle.

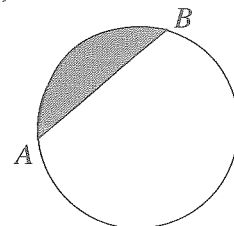

[see page two

6. The correct process that can be done by the construction method shown in the diagram is,
- (1) to separate a circle into even number of parts of equal size.
  - (2) to separate a circle into odd number of parts of equal size.
  - (3) to separate a circle into any number of parts of equal size.
  - (4) to separate a circle into two parts of equal size.

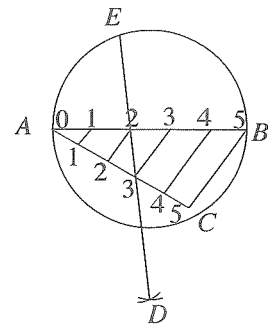

7. What is the correct answer which indicates the sum of the values of all angles included in the shown diagram?
- (1)  $180^\circ$
  - (2)  $240^\circ$
  - (3)  $320^\circ$
  - (4)  $360^\circ$

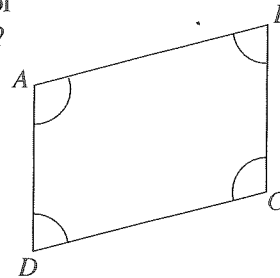

8. What is the polygon that shows the characteristics listed below?
- Length of all sides are equal.
  - Value of each angle is  $90^\circ$ .
  - Diagonals are equal to each other.
  - Opposite sides are parallel.

- (1) Trapezium      (2) Square      (3) Rectangle      (4) Rhombus

9. When creating a polygon with minimum number of sides, the number of sides should be drawn are,
- (1) 3                      (2) 4                      (3) 6                      (4) 7

10.

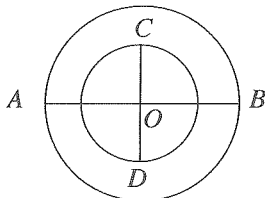

One of the initial steps in drawing an ellipse using concentric circle method is shown in the diagram. The major axis of the ellipse drawn using this method is,

- (1) A - O line segment.                      (2) A - B line segment.  
 (3) C - O line segment.                      (4) C - D line segment.

11. In dyeing, different hues are obtained by mixing colours. Hues that are mixed to prepare green colour are
- (1) blue and yellow.                      (2) purple and red.  
 (3) blue and white.                      (4) red and yellow.
12. 'Brushes', the most important equipment in cloth painting, should be selected according to the task performed. The brush that should be selected to draw refined lines, tiny dots, etc. is a,
- (1) brush of nos. 04 to 09.  
 (2) brush of  $\frac{1}{2}$  cm.  
 (3) flat brush marked with no. 01.  
 (4) brush of nos. 00 to 03.

[see page three

13. The expected outcome of bleaching textiles, during the pre-treatment process before colouring textiles is,
- (1) to remove natural dirt in textiles.
  - (2) to remove starch in textiles.
  - (3) to remove greyish colour from textiles.
  - (4) to remove stains from textiles.
14. To obtain white, red and black hues for a shirt made out of white cloth using the Batik decoration method, how many times does it require to be dipped in dyes?
- (1) Once                      (2) Twice                      (3) Three times                      (4) Four times
15. What is the best suited type of fibre to make clothes for people in tropical countries?
- (1) woollen fibre                      (2) mineral fibre
  - (3) artificial fibre                      (4) cotton fibre
16. To print textiles in the classroom using the block printing method, a block could be created out of,
- (1) potato.                      (2) ladies fingers.
  - (3) lotus yam.                      (4) a piece of banana leaf stem.
17. Decorative bands are woven with the use of tablets. Width of the woven band could be increased by,
- (1) increasing the number of thread used for tablets.
  - (2) using large sized tablets.
  - (3) increasing the number of tablets used.
  - (4) increasing the number of holes in a tablet.
18. The decoration method used to join a piece of fabric with a pattern, to a surface of another fabric decoration without sewing is known as,
- (1) patchwork method.                      (2) heet'n bond method.
  - (3) network method.                      (4) Brazilian embroidery method.
19. Given below are some steps of a method used for screen printing.
- A – fixing the piece of cloth on the base board.  
B – pasting the stencil on the screen  
C – cutting the stencil of the relevant design  
D – Applying paint after positioning the screen on the piece of cloth
- Select the option that indicates the correct order of steps in that process.
- (1) A, B, C, D                      (2) A, C, D, B                      (3) B, C, D, A                      (4) C, B, A, D
20. At first, the sticky glue on silk thread should be removed when preparing silk thread for weaving. This glue removal process is done by,
- (1) boiling thread in soap water for 2 hours and washing with clean water.
  - (2) soaking thread in salt water for 12 hours and washing with clean water.
  - (3) immersing thread in lime water for 24 hours and washing with water.
  - (4) keeping thread in lukewarm water for 2 days and washing with water.

21. When stitching by hand, the temporary stitch that is used until the permanent stitch is done, is the,  
 (1) Running stitch. (2) Back stitch. (3) Chain stitch. (4) Satin stitch.

22. The diagram given below shows the method of stretching yarn in rows of healds, when a weave is graphically illustrated. This method of weaving yarn is known as,

- (1) matte weave.  
 (2) plain weave.  
 (3) regular twill weave.  
 (4) weft rib weave.

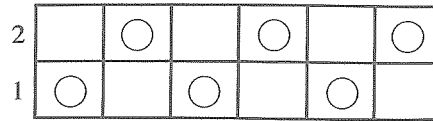

23. The weight of a bale of single thread skein of metric number 40 is 20kg. How many thread skeins are there in that bale of yarn?

- (1) 80 (2) 200 (3) 400 (4) 800

24. To weave a bed sheet, 30 number of two-ply skeins were consumed. If one kilogram consists of 40 two-ply skeins, the yarn number of the same is,

- (1)  $2^s/30$  (2)  $2^s/40$  (3)  $2^s/80$  (4)  $2^s/100$

25. In a serviette warp that is 80m long and 20cm wide, 40 number of warp thread are used for one centimetre. The number of warp thread in that warp is,

- (1)  $20 \times 20 = 400$ . (2)  $20 \times 40 = 800$ .  
 (3)  $40 \times 40 = 1600$ . (4)  $40 \times 80 = 3200$ .

26. Following are some diagrams of weave patterns used in weaving curtain cloth. Select the thread presenting method in the  $\frac{2}{2}$  spiral weaving pattern among them.

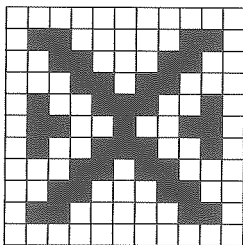

(1)

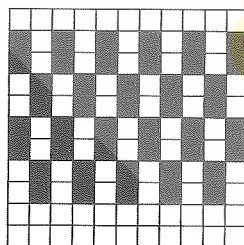

(2)

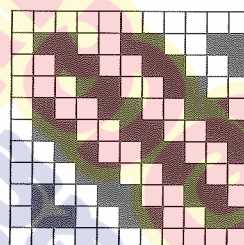

(3)

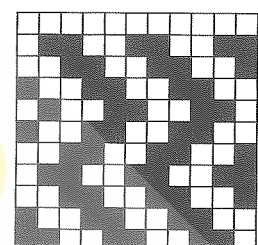

(4)

27. By leasing the warp in the process of weaving, it is expected to,  
 (1) prevent the yarn from breaking and to increase the weaving speed.  
 (2) obtain warp slots for weft thread and to maintain the width.  
 (3) prevent entanglement of thread and to separate them individually.  
 (4) draw thread according to the pattern and to maintain the strength of the edge.

28. In a piece of cloth that is used to sew a school uniform, a weaving pattern of one warp thread and one weft thread is used. Select the diagram that shows how the thread is projected out in the same weaving pattern, out of the diagrams given below.

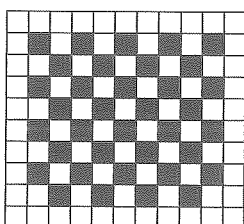

(1)

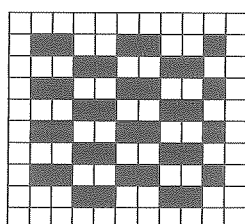

(2)

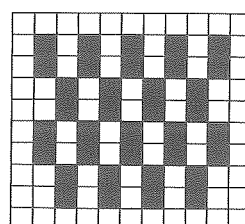

(3)

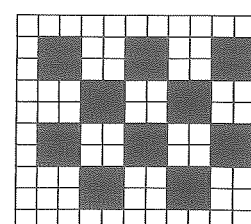

(4)

[see page five

29. When inserting a warp on to a loom, yarn should be spread according to the weaving pattern. The accessory fixed on to the loom for the same is the,
- (1) reed (comb).
  - (2) cross lams.
  - (3) rows of healds.
  - (4) treadles.
30. All thread is spread out before the warp is fixed on to the loom. The set of instruments used for the same is,
- (1) swift, winding machine and swift frame.
  - (2) creel, heck and warp drum.
  - (3) bobbin, fly shuttle loom and treadles.
  - (4) reed (comb), rows of healds and drawing hook.
31. Clay or alumina silicate is formed by decayed mother rock termed 'feldspar'. The type of clay used for production of clay objects among the following is,
- (1) colloidal particles smaller than 0.002mm.
  - (2) clay particles of size 0.202mm.
  - (3) clay particles of size 1.002mm.
  - (4) colloidal particles larger than 2.002mm.
32. The type of clay used in producing toothpaste, medicine wraps, paint and heat insulators is,
- (1) secondary clay.
  - (2) fire clay.
  - (3) ball clay.
  - (4) primary clay.
33. Certain qualities of clay are required when producing standardized products. Out of those, the essential quality required to produce decanters is,
- (1) plasticity.
  - (2) porosity.
  - (3) clarity of colour.
  - (4) shrinkage.
34. Clay box is used to store prepared clay body safely. The inner walls of this box is lined with,
- (1) iron plate.
  - (2) copper plate.
  - (3) zinc plate.
  - (4) aluminium plate.
35. A dried clay pot coloured in black can be decorated by dipping it in a container of water with floating oil paint on it and obtaining the floating paint on to the pot. This decoration technique is known as,
- (1) marble technique.
  - (2) ongobe technique.
  - (3) decoupage technique.
  - (4) colour sprinkling technique.
36. There are different stages and techniques of decorating clay pots. Select the option that include techniques that can be applied during the leather hard stage.
- (1) Applying colour, applying pulp work
  - (2) Hand painting, block painting
  - (3) Applying paint, drawing
  - (4) Carving, piercing holes

[see page six

37. Different types of moulds are used in producing ceramic objects. The type of mould that should be used to produce the form given in the diagram is,

- (1) a mould with a single part.
- (2) a mould with two parts.
- (3) a mould with three parts.
- (4) a complex mould.

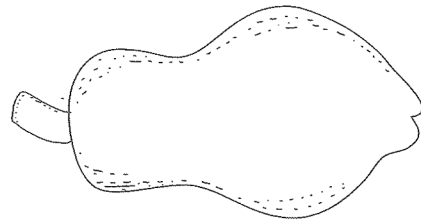

38. When producing a clay object on the potters wheel, the process applied to raise and press the lump of clay up and down with the use of both hands is known as,

- (1) centering the lump of clay.
- (2) obtaining texture.
- (3) opening the lump of clay.
- (4) raising up the wall of the pot.

39. The best method that can be used to create the clay wall plaque given in the picture is,

- (1) building on the potters wheel.
- (2) using clay coil method.
- (3) using clay slab method.
- (4) using modeling method.

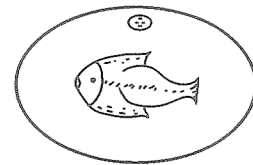

40. The range of temperature that should be maintained, in the kilns used by local potters to fire clay kitchen utensils is,

- (1) 850°C - 900°C.
- (2) 900°C - 1200°C.
- (3) 1200°C - 1250°C.
- (4) 1250°C - 1350°C.

\*\*

සියලු ම හිමිකම් ඇවිරිණි / முழுப் பதிப்புரிமையுடையது / All Rights Reserved

ශ්‍රී ලංකා විභාග දෙපාර්තමේන්තුව ශ්‍රී ලංකා විභාග දෙපාර්තමේන්තුව ශ්‍රී ලංකා විභාග දෙපාර්තමේන්තුව ශ්‍රී ලංකා විභාග දෙපාර්තමේන්තුව ශ්‍රී ලංකා විභාග දෙපාර්තමේන්තුව  
 இலங்கைப் பரீட்சைத் திணைக்களம் இலங்கைப் பரීட்சைத் திணைக்களம் இலங்கைப் பரීட்சைத் திணைக்களம் இலங்கைப் பரීட்சைத் திணைக்களம் இலங்கைப் பரීட்சைத் திணைக்களம்  
 Department of Examinations, Sri Lanka Department of Examinations, Sri Lanka Department of Examinations, Sri Lanka Department of Examinations, Sri Lanka Department of Examinations, Sri Lanka  
 இலங்கைப் பரීட்சைத் திணைக்களம் இலங்கைப் பரීட்சைத் திணைக்களம் இலங்கைப் பரīட்சைத் திணைக்களம் இலங்கைப் பரīட்சைத் திணைக்களம் இலங்கைப் பரīட்சைத் திணைக்களம்  
 Department of Examinations, Sri Lanka Department of Examinations, Sri Lanka Department of Examinations, Sri Lanka Department of Examinations, Sri Lanka Department of Examinations, Sri Lanka

84 E I, II

අධ්‍යයන පොදු සහතික පත්‍ර (සාමාන්‍ය පෙළ) විභාගය, 2020  
 கல்விப் பொதுத் தராதரப் பத்திர (சாதாரண தர)ப் பரீட்சை, 2020  
 General Certificate of Education (Ord. Level) Examination, 2020

ශිල්ප කලා	I, II
நுண்கலை	I, II
Arts and Crafts	I, II

### Arts and Crafts II

\* Answer five questions only, including question one and four other questions.

- Currently where development of local industries are given prominence, the association of self employees intend to hold an exhibition named "our strength for nation's development".
  - Create a suitable poster to make people aware of this exhibition.
  - Create a suitable invitation card to invite guests for the opening ceremony of this exhibition.
  - Draw a structure of an oil lamp that can be created using environmental resources, which is suitable to light at the occasion.
  - Draw an emblem to be worn by the members of the association of self employees, in order to identify them specifically.
  - Name two products made out of pieces of cloth, which can be exhibited in the stalls at the exhibition.
  - Draw a model of a pendant for a necklace that can be made using clay to be sold at the exhibition.
  - Name the two techniques which can be used to create batik arts to display at a stall reserved for batik industry.
  - A tapestry made out of ribbon and thread was price marked as Rs.1500/=. If the discount given is 10%, calculate the total sum of rupees, a person who purchase the product should spend on it.
  - Draw a suitable design for a commemorative plaque to be presented for the best artists.
  - It is expected to award gifts to those who exhibit skills in order to encourage them. Draw a sketch of a suitable package made out of paper that can hold the gifts.

- Geometrical drawing is used as a subject for technical drafting of designs made out of different material.

- Draw the straight line  $AB$  which is of 7 cm in length and bisect it.
- Create the trapezium of which  $PQ$  side is 3 cm and  $RS$  side is 5 cm.
- A tea package presented for the export market for sale is shown in this drawing. Using the measurements given, create development-drawings for the package.

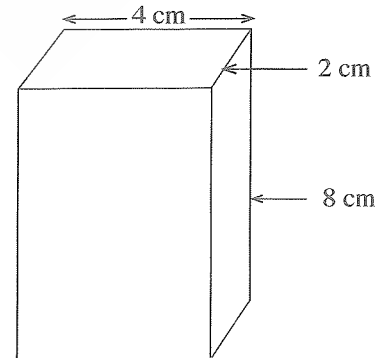

[see page eight

3. Both traditional and modern methods are used to decorate textiles.

- (i) Name a method where textiles are decorated without using dyes.
- (ii) Name **four** materials used to create artificial beads.
- (iii) Draw a suitable design that could be created out of batik and describe how it can be coloured using only one colour.

4. Given below is a description and a rough drawing of a warp created for a serviette warp.

- \* Length of the warp is 100m
- \* Width of the warp is 50cm
- \* There are 36 threads per one centimetre
- \*  $2^s/60$  is the number of the warp yarn

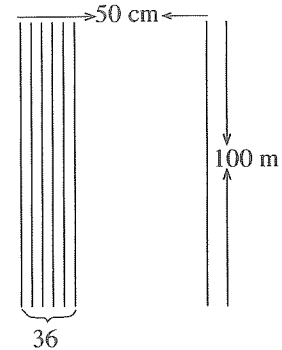

- (i) Name **two** weaving patterns used for weaving serviettes.
- (ii) Out of the weaving patterns named above, select one and graphically illustrate the fixing of thread, method of operating the treadles and method of overlaying thread.
- (iii) Calculate the weight of weft thread required for the warping board.

5. Textile technology started with hand operated looms and it increased its speed of production with the use of power looms and the industry developed further with the use of many other types of looms for decoration.

- (i) Name the loom that is used to weave decorations that spread out all over the surface.
- (ii) Describe the function of a lever of a weaving loom.
- (iii) Write short notes on 'rows of healds' and 'reed (comb)' used as accessories of the weaving loom.

6. Currently there is a good demand for ceramic objects.

- (i) Name **two** natural causes that effect the formation of clay.
- (ii) Some types of kilns are categorised according to the method the fire flames travel. Name **two** types of kilns among those categories and write short notes on them.
- (iii) Write down the steps in order, of the process of making a clay object on the potter's wheel.

7. From ancient times, humans were interested in beautifying their natural environment.

- (i) Define the principle term 'ratio' used in garden landscape.
- (ii) Draw a sketch for a wall sculpture for the front wall of a tourist guest house that holds the entrance doorway.
- (iii) Describe the process of making a sculpture out of paper pulp in the classroom.

\* \* \*



# 10 සහ 11 ශ්‍රේණි සඳහා ග්‍රන්ථ නාමාවලිය

## (අ.පො.ස) සාමාන්‍ය පෙළ 11 ශ්‍රේණිය - කෙටි සටහන්

### සිංහල මාධ්‍ය

- 10-11 සිංහල ව්‍යාකරණ
- 10-11 සිංහල සාහිත්‍යය රසාස්වාදය
- බුද්ධ ධර්මය
- කතෝලික ධර්මය
- සිංහල භාෂාව හා සාහිත්‍යය
- සිංහල සාහිත්‍යය සංග්‍රහය
- English Language
- ගණිතය - 1
- ගණිතය - 2
- ජීව විද්‍යාව
- භෞතික විද්‍යාව
- රසායන විද්‍යාව
- ඉතිහාසය
- ව්‍යාපාර හා ගිණුම්කරණ අධ්‍යයනය
- භූගෝල විද්‍යාව
- පුරවැසි අධ්‍යාපනය
- පෙරදිග සංගීතය
- නර්තනය
- නාට්‍ය හා රංග කලාව
- චිත්‍ර කලාව
- තොරතුරු හා සන්නිවේදන තාක්ෂණය
- සන්නිවේදනය හා මාධ්‍ය අධ්‍යයනය
- සෞඛ්‍යය හා ශාරීරික අධ්‍යාපනය
- කෘෂි හා ආහාර තාක්ෂණය
- ගෘහ ආර්ථික විද්‍යාව

## 11 ශ්‍රේණිය - ප්‍රශ්නෝත්තර

### සිංහල මාධ්‍ය

- සිංහල භාෂාව හා සාහිත්‍යය
- බුද්ධ ධර්මය
- ඉතිහාසය
- ව්‍යාපාර හා ගිණුම්කරණ අධ්‍යයනය
- පුරවැසි අධ්‍යාපනය

## Grade 11 - Short Notes

### English Medium

- Buddhism
- Mathematics - 1
- Mathematics - 2
- Biology
- Physics
- Chemistry
- History
- Business & Accounting Studies
- Geography
- Civic Education
- ICT
- Health & Physical Education
- 10-11 English Literary (Poetry)
- 10-11 English Literary (Drama)
- 10-11 English Literary (Short Story)

## Grade 11 - Model Papers

### English Medium

- Civic Education

## 10 ශ්‍රේණිය - කෙටි සටහන්

### සිංහල මාධ්‍ය

- බුද්ධ ධර්මය
- කතෝලික ධර්මය
- සිංහල භාෂාව හා සාහිත්‍යය
- සිංහල සාහිත්‍යය සංග්‍රහය
- සිංහල රචනා අත්වැල
- English Language
- ගණිතය - 1
- ගණිතය - 2
- ජීව විද්‍යාව
- භෞතික විද්‍යාව
- රසායන විද්‍යාව

# Grade 10 - Short Notes

English Medium

- ඉතිහාසය
- ඉතිහාසය රූප සටහන් අග්‍රිත කෙටි සටහන්
- ව්‍යාපාර හා ගිණුම්කරණ අධ්‍යයනය - 1
- ව්‍යාපාර හා ගිණුම්කරණ අධ්‍යයනය - 2
- භූගෝල විද්‍යාව
- පුරවැසි අධ්‍යාපනය
- පෙරදිග සංගීතය
- නර්තනය
- නාට්‍ය හා රංග කලාව
- චිත්‍ර කලාව
- තොරතුරු හා සන්නිවේදන තාක්ෂණය
- සන්නිවේදනය හා මාධ්‍ය අධ්‍යයනය
- සෞඛ්‍යය හා ශාරීරික අධ්‍යාපනය
- කෘෂි හා ආහාර තාක්ෂණය
- ගෘහ ආර්ථික විද්‍යාව
- ජපන් භාෂාව

- Buddhism
- Mathematics - 1
- Mathematics - 2
- Biology
- Physics
- Chemistry
- History
- Business & Accounting Studies - 1
- Business & Accounting Studies - 2
- Geography
- Civic Education
- ICT
- Health & Physical Education

## 10 ශ්‍රේණිය - ප්‍රශ්නෝත්තර

සිංහල මාධ්‍ය

- සිංහල භාෂාව හා සාහිත්‍යය
- බුද්ධ ධර්මය
- ගණිතය
- විද්‍යාව
- ඉතිහාසය
- පුරවැසි අධ්‍යාපනය
- භූගෝල විද්‍යාව
- පෙරදිග සංගීතය

## Grade 10 - Model Papers

English Medium

- Mathematics
- Science
- Civic Education
- Geography
- English Activity Book
- English Work Book

### අනෙකුත් ග්‍රන්ථ

- හෙළදිව කතිකාවත  
- අරුණශාන්ත අමරසිංහ
- හොල්මන් අවතාර සහ යකඳුරන්  
- අරුණශාන්ත අමරසිංහ
- සිසු-ගුරු අත්පොත නාට්‍ය හා රංග කලාව 10-11 ශ්‍රේණි සඳහා (නව විෂය නිර්දේශය) - තන්දන අල්ගේවත්ත

## පාඩමෙන් පාඩමට මාසික ඇගයීම්

සිංහල මාධ්‍ය

- 10-ශ්‍රේණිය - විද්‍යාව
- 11-ශ්‍රේණිය - විද්‍යාව

සියලු ම ශ්‍රේණි සඳහා කෙටි සටහන්, ප්‍රශ්න පත්‍ර කට්ටල සහ වැඩ පොත් අප සතුව තිබෙන අතර, මෙම ඕනෑම ග්‍රන්ථයක් වට්ටම් සහිත ව ඔබේ නිවසට ම ගෙන්වා ගත හැකි ය.